

POP OUT ROUND ACCESS PANEL 12" DIAMETER

GFRG-RD-580012

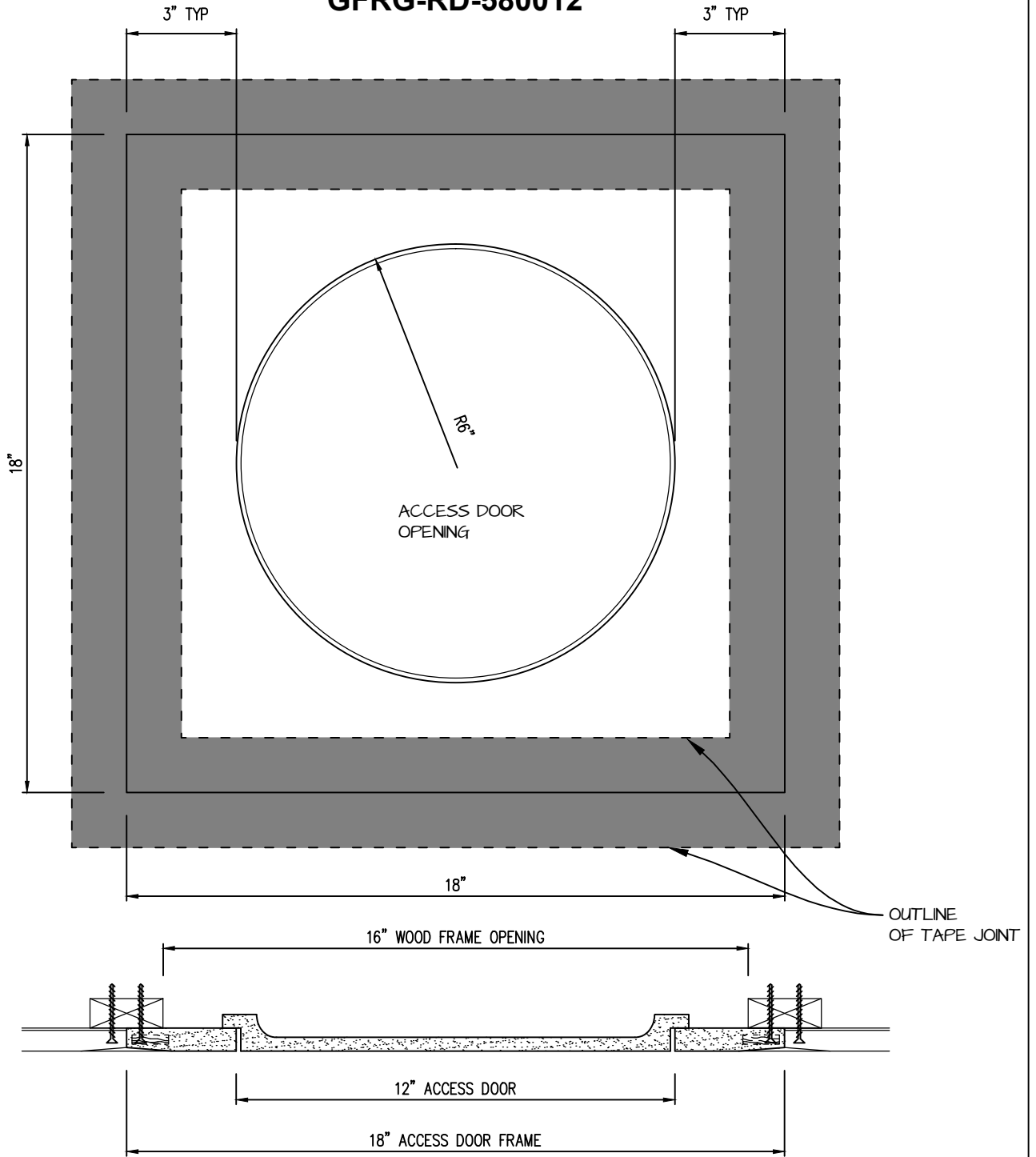

CASTLE ACCESS PANELS & FORMS INC.

173 Adesso Drive, Unit 2, Concord ON L4K 3C3

Phone (905)738-8089 Fax (905)760-9234

inquiries@castleaccesspanels.com

www.CastleAccessPanels.com

DESIGNED: Q.P

DATE:

APPROVED: J.R

CUSTOMER:

PROJECT:

QTY:

TITLE:

DWG NO:

SHEET OF

POP-OUT GFRG ACCESS PANEL SECTION

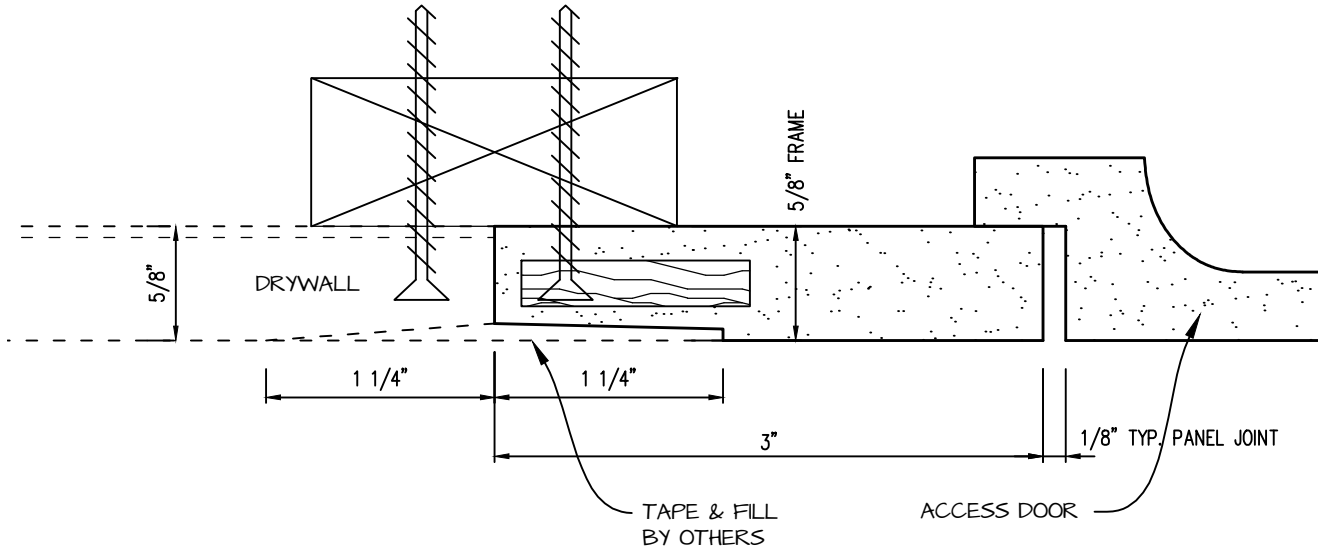
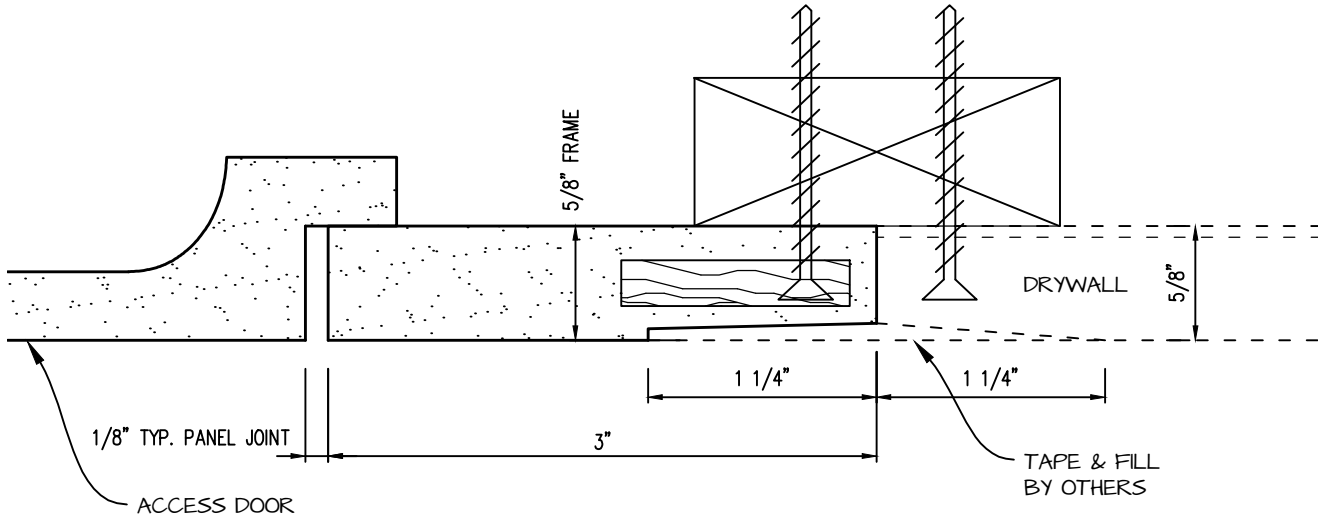

| | | |
|--|---------------|----------|
|  <p>CASTLE ACCESS PANELS & FORMS INC. 173 Adesso Drive, Unit 2, Concord ON L4K 3C3 Phone (905)738-8089 Fax (905)760-9234 inquiries@castleaccesspanels.com www.CastleAccessPanels.com</p> | DESIGNED: Q.P | |
| | DATE: | |
| | APPROVED: J.R | |
| CUSTOMER: | PROJECT: | QTY: |
| TITLE: | DWG NO: | SHEET OF |