

DE TAPAS SUeltas, ESQUINAS CUADRADAS PANEL 30"x48"
GFRG-SQ-583048 (especial de 2 puertas con ventilación)

VISTA DE ARRIBA

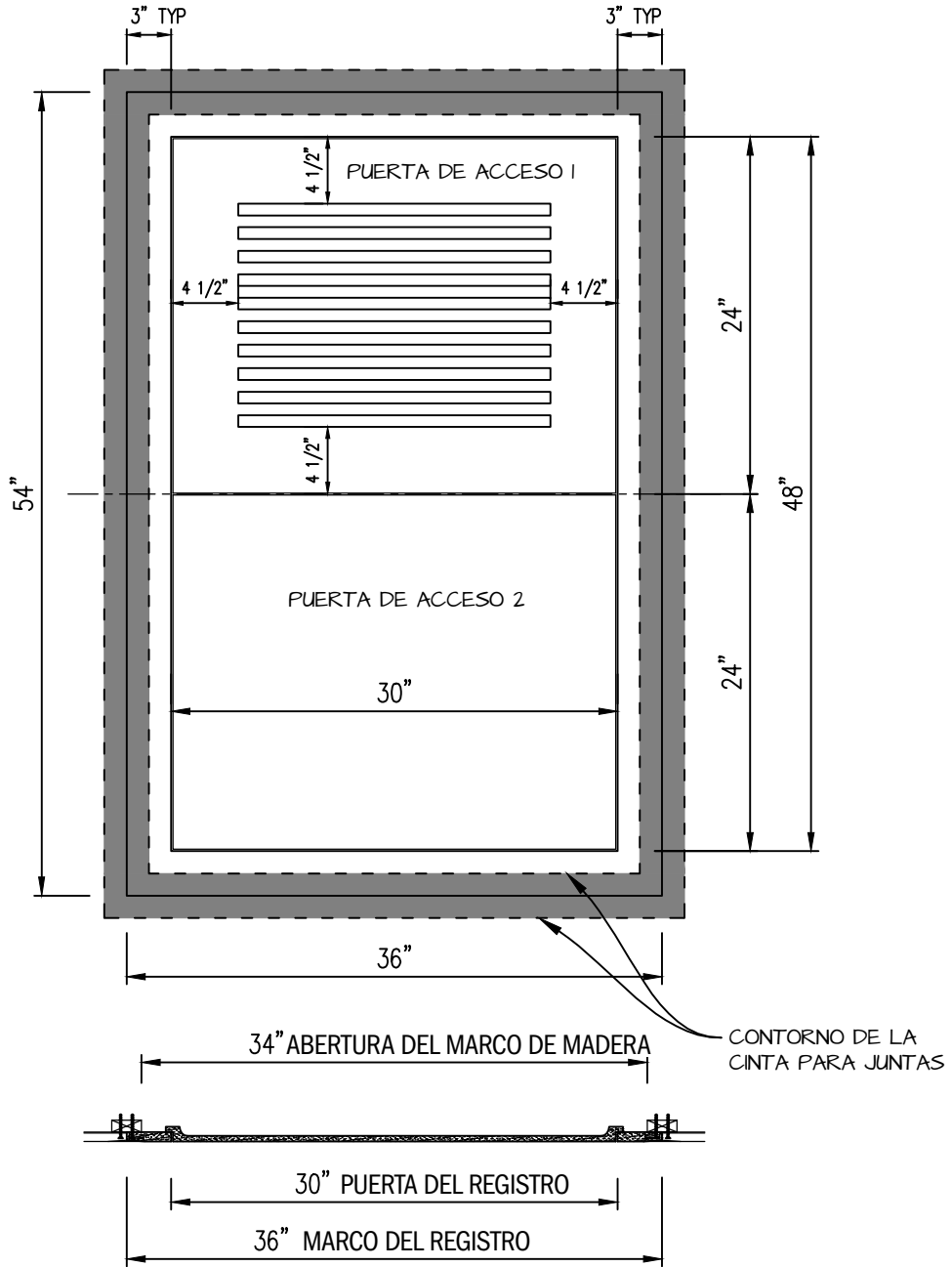

 <p>CASTLE ACCESS PANELS & FORMS INC. 173 Adesso Drive, Unit 2, Concord ON L4K 3C3 Phone (905)738-8089 Fax (905)760-9234 inquiries@castleaccesspanels.com www.CastleAccessPanels.com</p>	DESIGNED: Q. P.	
	DATE:	
	APPROVED: J. R.	
	DATE:	
CUSTOMER:	PROJECT:	QTY:
TITLE:	DWG NO:	SHEET OF

REGISTRO CON TAPA SUELTA

VISTA EN CORTE

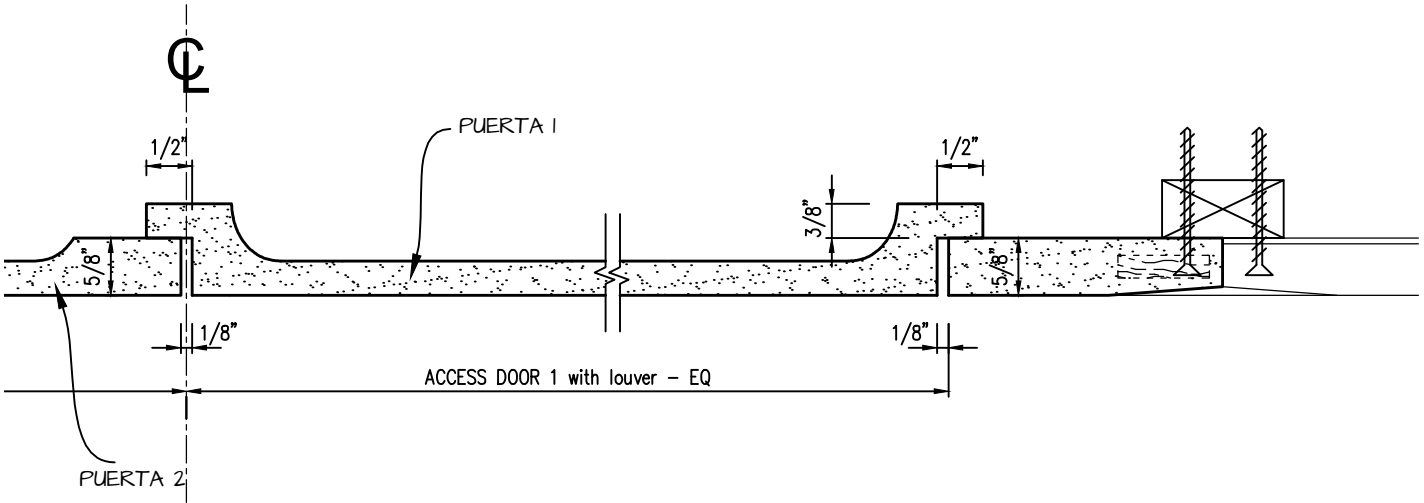
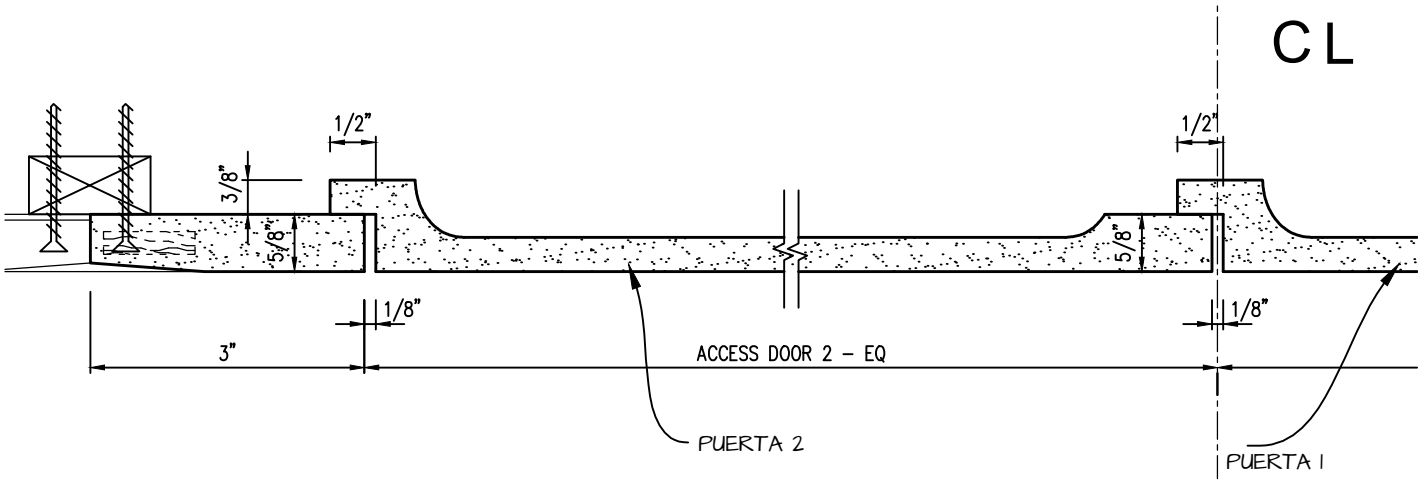

DE TAPAS SUELTAS ESQ. CUADRADAS PANEL 30"x48"
GFRG-SQ-583048 (especial 2 puertas con ventilación)

TAPAS CERRADAS

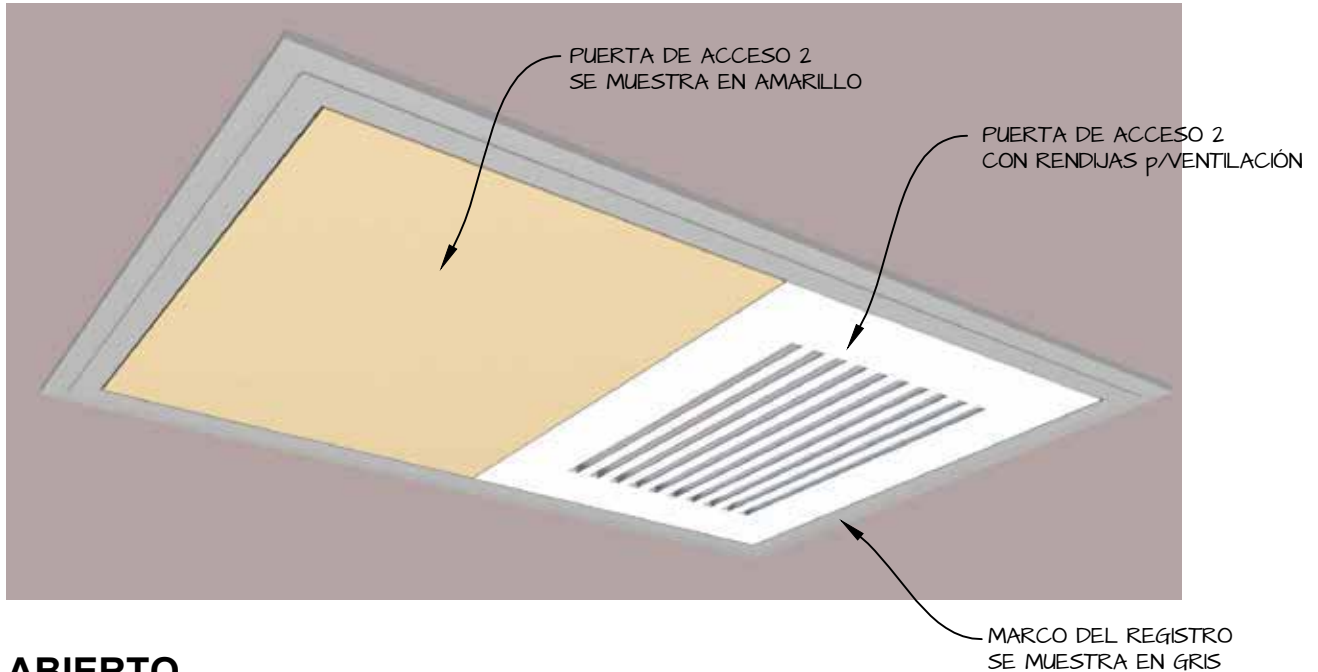

ABIERTO

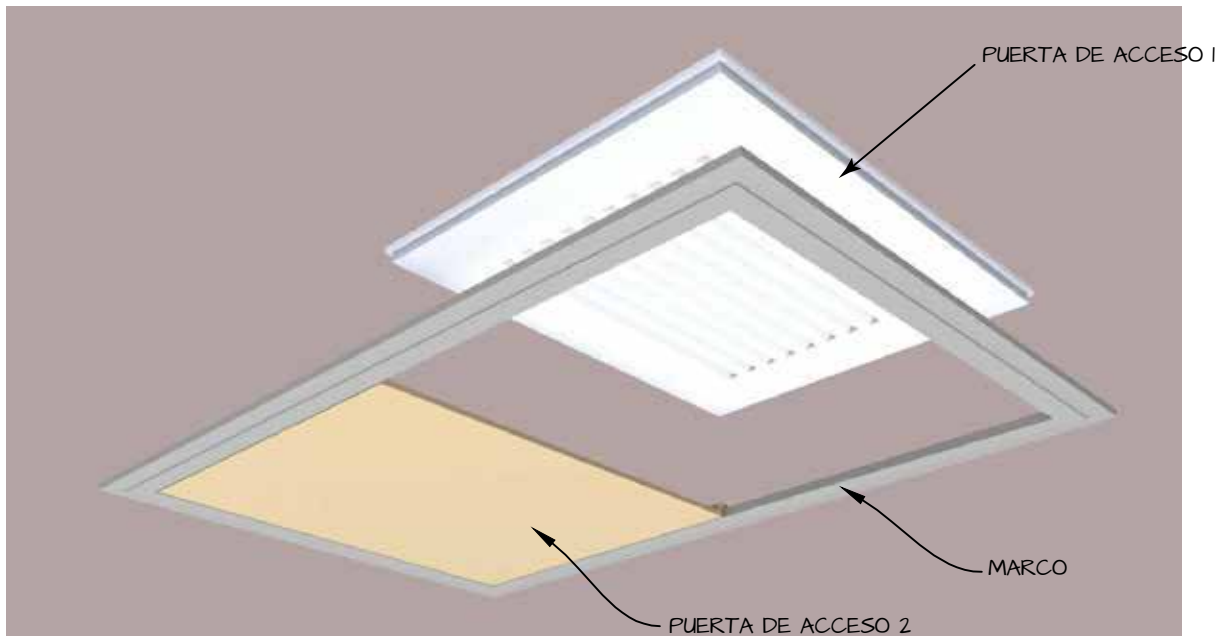

 <p>CASTLE ACCESS PANELS & FORMS INC. 173 Adesso Drive, Unit 2, Concord ON L4K 3C3 Phone (905)738-8089 Fax (905)760-9234 inquiries@castleaccesspanels.com www.CastleAccessPanels.com</p>	DESIGNED: Q. P.	
	DATE:	
	APPROVED: J. R.	
	DATE:	
CUSTOMER:	PROJECT:	QTY:
TITLE:	DWG NO:	SHEET OF

TAPAS SUELTAS, Esquinas cuadradas PANEL 30"x48"
GFRG-SQ-583048 (especial de 2 tapas con ventilación)

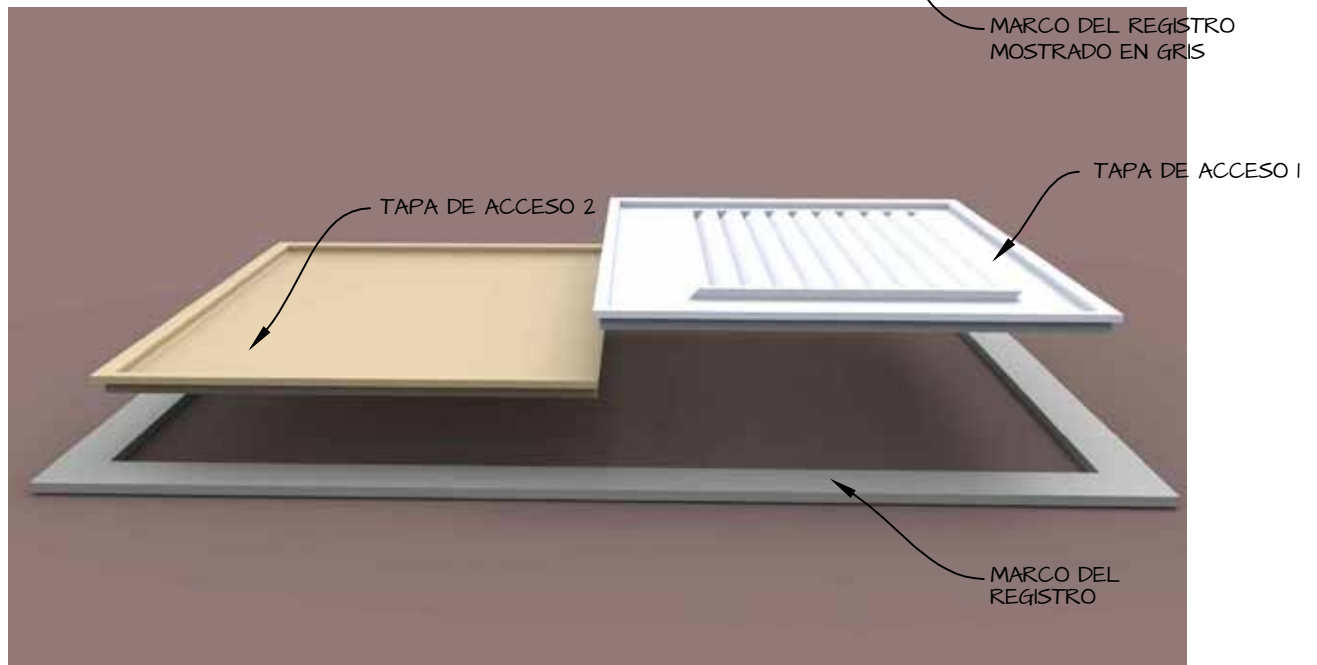
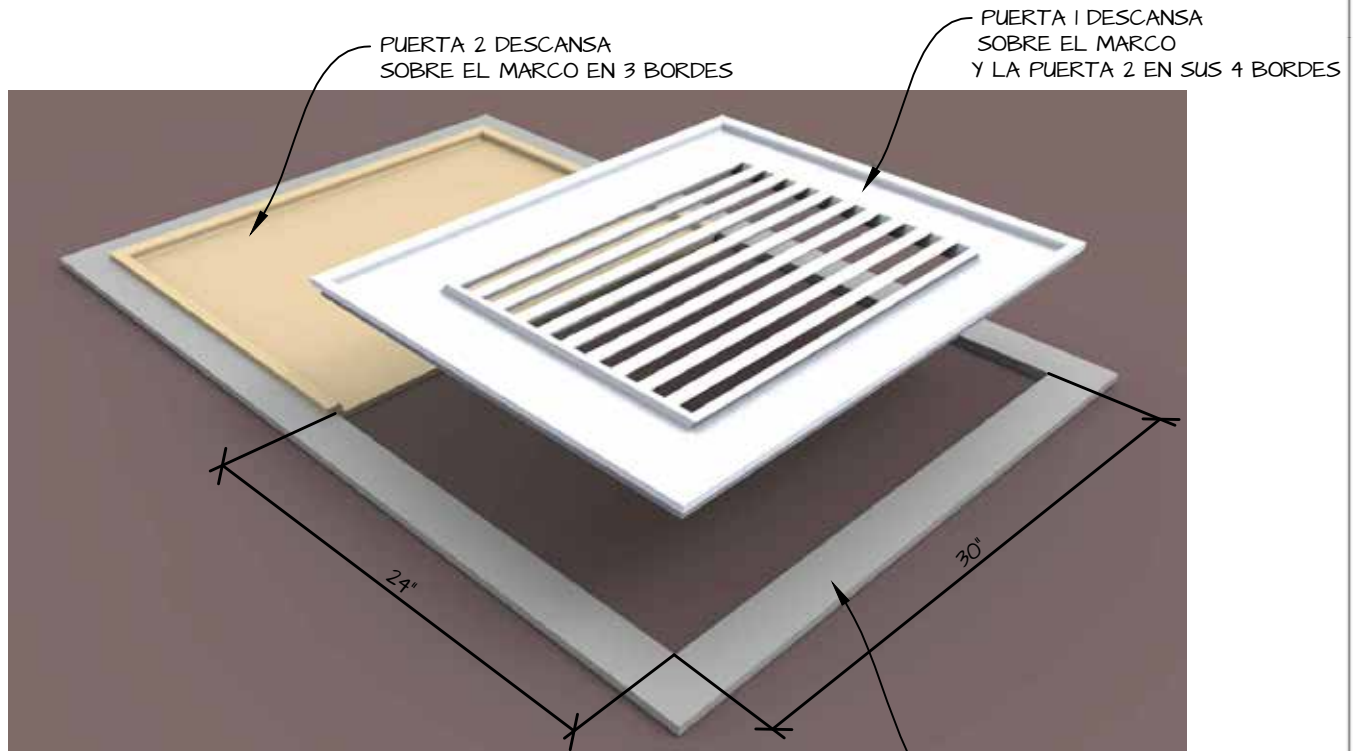

	CASTLE ACCESS PANELS & FORMS INC. 173 Adesso Drive, Unit 2, Concord ON L4K 3C3 Phone (905)738-8089 Fax (905)760-9234 inquiries@castleaccesspanels.com www.CastleAccessPanels.com	DESIGNED: Q. P.
		DATE:
		APPROVED: J. R.
		DATE:
CUSTOMER:	PROJECT:	QTY:
TITLE:	DWG NO:	SHEET OF